

# 2000 Slide Switches - up to 5 position 10A 250Vac

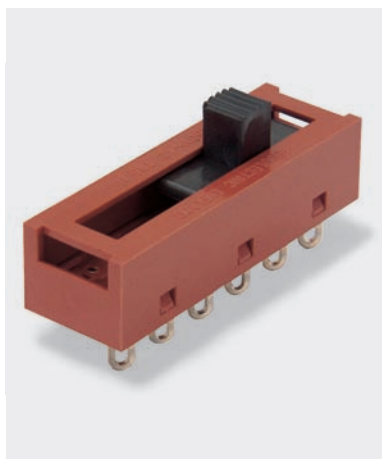

- ▶ Slide switches
- ▶ Ratings up to 16A, 250V ac
- ▶ PCB and solder terminals
- ▶ 2, 3, 4 and 5 position
- ▶ Choice of circuits
- ▶ Choice of actuators



10A 250Vac T85  
6(3)A 250Vac T85



UL CSA 16A 250Vac Non Inductive  
UL CSA 4A 300Vac  
UL 65°C, file no. E45221, CSA file no. LR10990



RoHS compliant

μ contact gap

Please specify: Standard action (SP116) or Light action (SP118).  
2000 series lubrication is inorganic and does not degrade plastics.

Technical data on pages 4 & 5.

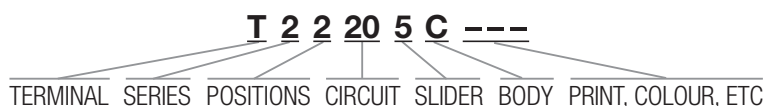

TERMINAL	SERIES	POS'N	CIRCUIT <small>Viewed from back</small>	SLIDER									
<p><b>K</b></p> <p>2.8 x 0.8</p> <p><b>R</b></p> <p>2.8 x 0.8</p> <p><b>T</b></p> <p>Solder</p> <p><b>X</b></p> <p>PCB 0.8 Sq.</p> <p><b>Y</b></p> <p>PCB 0.8 Sq. For mounting stability switches have extra "support" terminals</p> <p>* Nominal - Dimension varies with body type. For exact figure call sales</p>	2	2 Switching positions	10		<b>0</b>		<b>6</b>		<b>D</b>		<b>L</b>		
			20		<b>1</b>		<b>7</b>		<b>E</b>		<b>N</b>		
			30		<b>2</b>		<b>9</b>		<b>G</b>		<b>P</b>		
			40		3 Switching positions	<b>3</b>		<b>A</b>		<b>H</b>		<b>R</b>	
			10			<b>4</b>		<b>B</b>		<b>J</b>		<b>S</b>	
			20			4 Switching positions	<b>5</b>		<b>C</b>		<b>K</b>		<b>T</b>
		30		<b>6</b>				<b>L</b>					
		40		<b>7</b>				<b>M</b>					
		10		5 Switching positions			<b>8</b>		<b>O</b>				
		20			<b>9</b>			<b>P</b>					
		30			<b>0</b>			<b>Q</b>					
		40			<b>1</b>		<b>R</b>						
10		<b>2</b>			<b>S</b>								
20		<b>3</b>			<b>T</b>								



X22205C ---



T2220EC ---

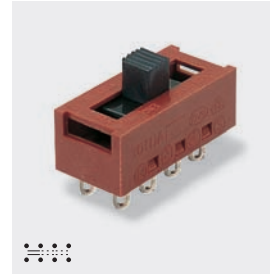

T23206A ---



T24306A ---



T25302A ---



T25100A ---

BODY		OPTIONS
<b>C</b> 2 positions 	<b>H</b> 2 positions 	<b>Colour</b> For custom slider colours call sales. A full range is available for large orders
<b>A</b> 3 positions 	<b>H</b> 3 positions 	
<b>A</b> 4 positions 	<b>H</b> 4 positions 	
<b>A</b> 5 positions 		

**DIMENSIONS** (mm)

**2 Position C body**

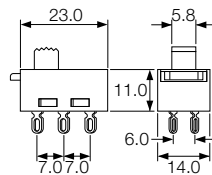

**2 Position H body**

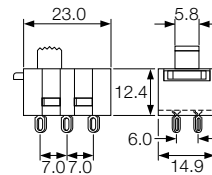

**Cut-out/PCB Matrix**

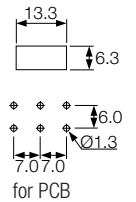

**3 Position A body**

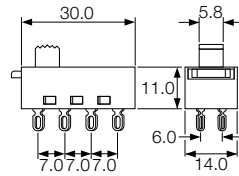

**3 Position H body**

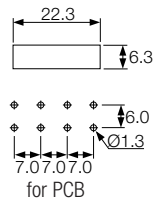
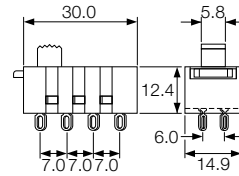

**4 Position A body**

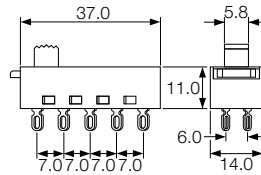

**4 Position H body**

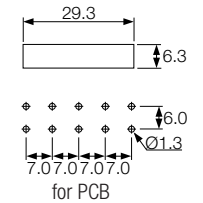
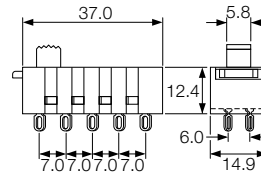

**5 Position A body**

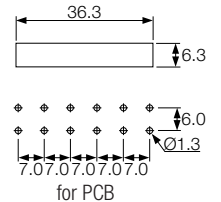
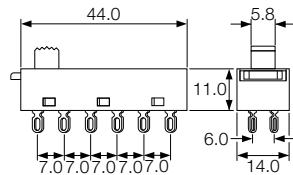

# 2000 Slide Switches - Snap fit and panel mount 10A 250Vac



- ▶ 2 way 'voltage selector'
- ▶ Ratings up to 10A, 250V ac
- ▶ Snap fit and panel mount
- ▶ PCB & solder terminals
- ▶ 2 and 3 position
- ▶ Choice of circuits
- ▶ Choice of actuators



10 A 250Vac T85  
6(3)A 250Vac T85



UL CSA 16A 250Vac Non Inductive  
UL CSA 4A 300Vac  
UL 65°C, file no. E45221, CSA file no. LR10990



RoHS compliant

μ contact gap

Please specify: Standard action (SP116) or light action (SP118).  
2000 series lubrication is inorganic and does not degrade plastics.

Technical data on pages 4 & 5.

115/230 is preferred legend

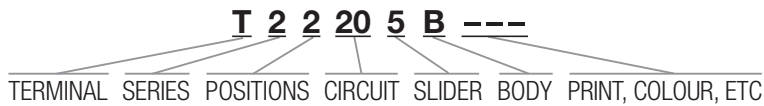

TERMINAL	SERIES	POS'N	CIRCUIT	SLIDER					
			<small>Viewed from back</small>						
<b>K</b>  2.8 x 0.8	2	Switching positions	10	0	6	C	L	S	
			20	2	7	D	M	T	
			30	3	8	E	N		
			40	4	9	H	P		
<b>R</b>  2.8 x 0.8	2	Switching positions	10	5	A	K	R		
			20	6					
			30	7					
			40	8					
<b>T</b>  Solder	2	Switching positions	10	9					
			20						
			30						
			40						
<b>X</b>  PCB 0.8 Sq. For mounting stability switches have extra "support" terminals * Nominal - Dimension varies with body type. For exact figure call sales	3	Switching positions	10						
			20						
			30						
			40						

slide switches



T22208E ---



T22308E ---



T2230MF ---



T22205B ---



T22305B ---



T23204B ---

**BODY**

**B** With mounting holes

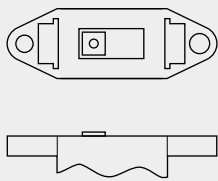

**E** Snap fit

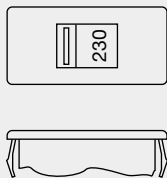

Cut-outs must be punched in the direction of insertion

**F** Snap fit (single pole ON OFF only)

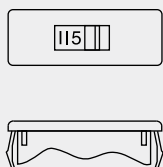

Cut-outs must be punched in the direction of insertion

**OPTIONS**

**Colour**

For custom slider colours call sales. A full range is available for large orders

Standard body colour is black

**Legend printing**

A wide range is available

For all options call sales

**DIMENSIONS (mm)**

**2 Pos B**

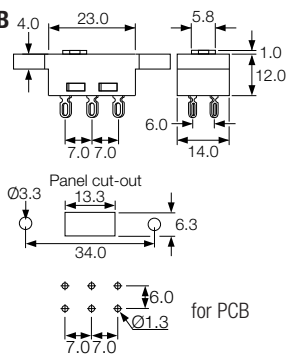

**Cut-out / PCB Matrix**

**3 Pos B**

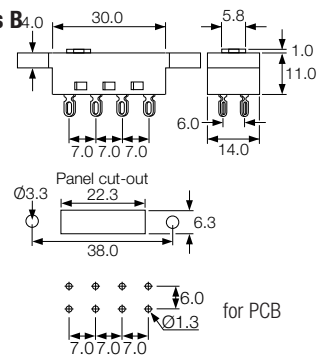

**2 Pos E**

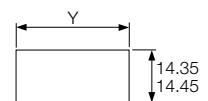
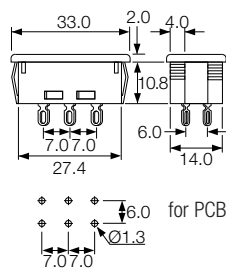

**2 Pos F**

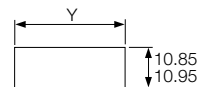
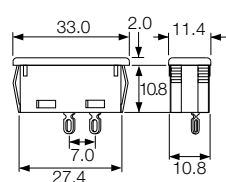

for PCB, call sales for details